

THE PROPERTY OF THIS DRAWING IS ESTABLISHED BY LAW
IT IS FORBIDDEN TO REPRODUCE IT OR SHOW IT TO THIRD PARTY
WITHOUT A WRITTEN AGREEMENT.

MODIFICATIONS: VARIED DIMENSIONS AS OF DATE:

7	10
8	11
9	12

MODIFICATIONS: VARIED DIMENSIONS AS OF DATE:

1	4
2	5
3	6

Format **A3**
UNI 936-76

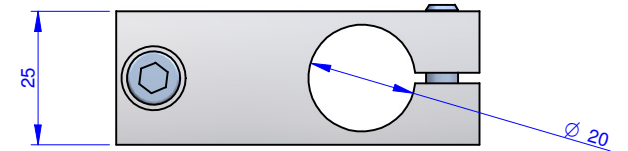
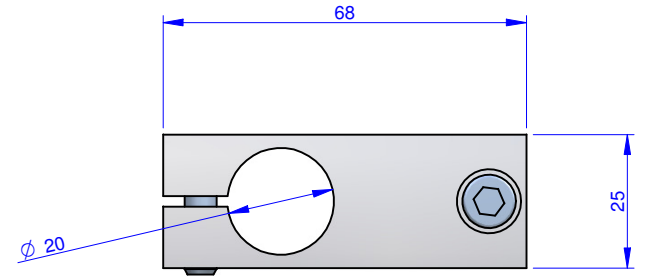
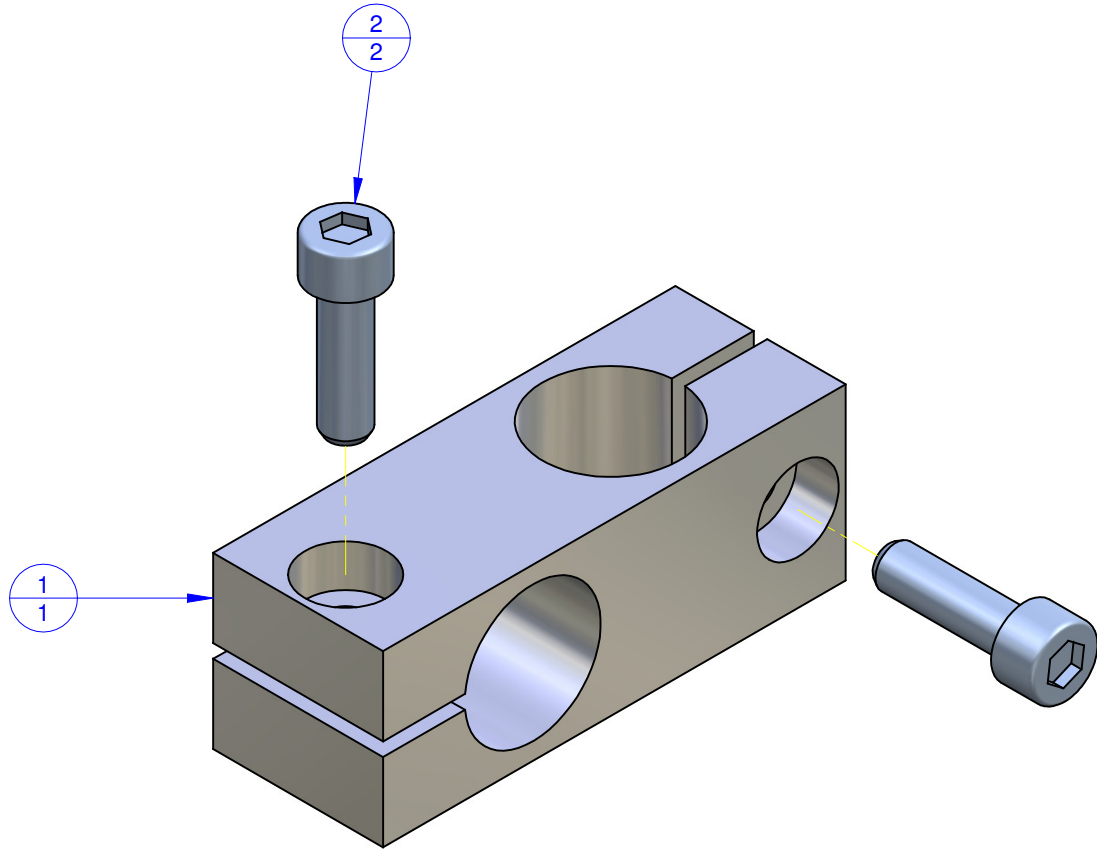

Object Number	Name	QTY
1	03.03.005	1
2	V.TCE6X20	2

FP Services		DESIGNED FROM FPSERVICES	
GENERAL TOLERANCE: UNI - ISO 2768 CLASSE f		DATE 11/2013	WEIGHT 0,079 kg
DESCRIPTION		CODE CA.03.03.005	